

SF
524
. 52
M3
S98



ALBERT R. MANN
LIBRARY
NEW YORK STATE COLLEGES
OF
AGRICULTURE AND HOME ECONOMICS
AT
CORNELL UNIVERSITY



EVERETT FRANKLIN PHILLIPS
BEEKEEPING LIBRARY

Bee Keeping in Maryland.



BULLETIN No. 154
OF THE
Maryland Agricultural Experiment Station
COLLEGE PARK, MD.
JUNE, 1911.

The Maryland Agricultural Experiment Station.

CORPORATION.

The Board of Trustees of the Maryland Agricultural College.

Agricultural (Station) Committee of the Board of Trustees.

GOVERNOR A. L. CROTHERS, L.L. D. (Ex-Officio).....	Annapolis.
CHAS. A. COUNCILMAN (Chairman).....	Glyndon.
DAVID SEIBERT.....	Clear Spring.
F. CARROLL GOLDSBOROUGH.....	Easton.
ROBERT CBAIN.....	Baltimore.
J. HAROLD WALSH.....	Upper Falls.
E. GITTINGS MERRYMAN.....	Cockeysville

STATION OFFICERS AND STAFF.

HARRY J. PATTERSON, B. S.....	<i>Director and Chemist.</i>
SAMUEL S. BUOKLEY, M. S., D. V. S.....	<i>Animal Pathologist.</i>
J. B. S. NORTON, M. S.....	<i>Botanist and Pathologist.</i>
*THOS. B. SYMONS, M. S.....	<i>Entomologist.</i>
C. P. CLOSE, M. S.....	<i>Horticulturist.</i>
N. SCHMITZ, M. S.....	<i>Agronomist.</i>
E. H. BRINKLEY.....	<i>Farm Superintendent.</i>
THOS. H. WHITE.....	<i>Gardener.</i>
GEO. EDWARD GAGE, Ph. D.....	<i>Biologist.</i>
CHAS. O. APPLEMAN, Ph. D.....	<i>Physiologist.</i>
A. B. GAHAN, M. S.....	<i>Associate Entomologist.</i>
ROY H. WAITE, B. S.....	<i>Associate Poultryman.</i>
W. R. BALLARD, B. S.....	<i>Assistant Horticulturist.</i>
L. B. BROUGHTON, B. S.....	<i>Assistant Chemist.</i>
*E. N. COBY, B. S.....	<i>Assistant Entomologist.</i>
*O. G. BABCOCK, B. S.....	<i>Assistant Entomologist.</i>
R. S. ALLEN.....	<i>Assistant Dairyman.</i>
L. B. KIMBLE.....	<i>Stenographer.</i>
ROY C. TOWLES.....	<i>Clerk.</i>
H. FORD.....	<i>Treasurer.</i>

*On State Horticultural Department Work.

The Station is located on the B. & O. R. R. and City and Suburban Electric Car Line, eight miles north of Washington, D. C.
Bell Telephone—Hyattsville Exchange.

Visitors will be welcomed at all times, and will be given every opportunity to inspect the work of the Station in all of its departments.

The Bulletins and Reports of the Station will be mailed regularly, free of charge, to all residents of the State who request it.

ADDRESS:

AGRICULTURAL EXPERIMENT STATION,
College Park, Md.

THE MARYLAND AGRICULTURAL EXPERIMENT STATION

BULLETIN 154.

JUNE, 1911.

BEE KEEPING IN MARYLAND.

I. THE STATUS OF BEE KEEPING IN THE STATE.

By T. B. SYMONS.

INTRODUCTION.

The keeping of bees for profit is in its infancy in Maryland. Those who gain their entire livelihood from this business are few, but there are thousands who keep bees as a side issue to their regular business for either profit or pleasure. There is no industry in whose progress and protection the farming class as a whole should be more interested than in apiculture. It does not follow from this statement that all farmers should be bee keepers, for it is not the aim of the friends of apiculture to greatly increase the number of persons keeping bees, but to make better bee keepers of those already in the business. In the light of comparatively recent discoveries of the existence of serious communicable diseases among bees, it is specially urged that only those who are prepared to give the apiary proper attention, should undertake to keep bees even if only for pleasure.

The honey bee is an important factor as a pollenizing agent, especially in cross-pollinating the blossoms of many of our fruits. It has long been known that the blossoms of many varieties of fruit, as well as other plants, require cross pollination to set a full crop. It is probable that no other insect is superior to the honey bee in performing this service. Many practical fruit growers keep bees for this purpose, and the growers of the vegetables under glass, regularly introduce bees into their green houses to pollinate cucumbers and other flowers. Probably this useful insect can be given credit for causing some of our best varieties that have originated from seedlings. As the people of this state become more and more interested in horticulture, they must at the same time, bear in mind the protection of the honey bee, which aids them in producing full crops.

Aside from the great service rendered by the honey bee in cross pollinating the flowers of fruit trees and grains, its ability to manufacture the nectar into a most palatable food, which otherwise would

undoubtedly be lost to man, makes this insect a subject of unusual interest to the general public. It may not be out of place to comment here that notwithstanding the great increase in recent years in the manufacture of adulterated foods, no one has yet devised a method to manufacture comb honey. Moreover, with the passage of the Pure Food Law by Congress, inferior substitutes for extracted honey can no longer lawfully be sold under the name honey.

While the State of Maryland offers abundant opportunity for successful bee keeping, there are comparatively few progressive bee keepers in the state. There are however, thousands who keep a few colonies. These are too often kept under conditions, which are a menace to the industry.

While Maryland has not been prominent as a honey producing state, yet she has furnished some distinguished bee keepers. For several years Rev. L. L. Langstroth, who may be justly called the father of American apiculture, resided in Baltimore. His perfection of the movable frame hive revolutionized the industry in this country. Probably no improvement has been so universally adopted by the trade as the Langstroth's hive, and his writings on bee keeping speak for his genius. One of the hives originally owned by Mr. Langstroth was exhibited by Mr. Chas. H. Lake, a venerable and enthusiastic bee keeper of the state, at the 1909 meeting of the Maryland State Bee Keepers Association. Richard Colvin, who was one of the first to introduce the Italian bee to the United States, also lived in Baltimore. No doubt the enthusiasm and knowledge of the business of these men were a great incentive to Maryland bee keepers at that time.

The first work taken up at this Institution was conducted by Mr. Chas. H. Lake, now of Baltimore. Mr. Lake is a practical bee keeper, and a keen observer of the bees and their activities. He successfully conducted a large apiary at the College from 1896 to 1899. During these years he did much to educate the bee keepers of the state, by making exhibits and otherwise giving information regarding bee keeping.

Prior to the fall of 1910, practically nothing had been done by this department to aid bee keeping. At this time, through the efforts of the department, a State Bee Keepers Association was formed for the purpose of bringing the bee keepers of the state together, so that a general exchange of ideas would aid in bettering the conditions in the State. At the same time there was inaugurated some cooperative work with the Bureau of Entomology, United States Department of Agriculture, which made possible a limited investigation of the status of the industry in the State. A preliminary report of this investigation by the writer, together with a discussion of the management of the apiary by A. H. McCray, Apicultural Assistant, U. S. Department of Agriculture, is here given with the hope that suggestions made will be helpful to the bee keepers.

THE NEEDS OF SUCH AN INVESTIGATION.

As pointed out above, prior to 1908, very little had been done in this State to promote scientific apiculture. The only information available concerning the industry in the State was that given by the census of 1900. It was there stated that 5,098 farmers in Maryland had reported 28,013 colonies. These bees produced in 1899, 306,788 pounds of honey and 7,860 pounds of wax, valued at \$38,857. Few people are aware that the industry amounted even to this much, as it had not been promoted in any organized manner, and even the few individual expert bee keepers had not properly advertised their business.

While brood diseases of bees had been reported from Maryland by the Bureau of Entomology United States Department of Agriculture, no extensive attempt had been made to ascertain the distribution of these diseases, or to prevent their spread by the education of the bee keeper in the best method of treatment and prevention. No attempt had been made to increase the demand for pure honey in our markets, and thus curtail the sale of the cheap manufactured syrup compounds. The bee keepers who were in the business, were working independently and not cooperatively, and those who desired to improve their apiaries had no opportunity to exchange views with their associates in the business, and few were aware of the sources for up-to-date information concerning the business.

RESULTS OF COÖPERATIVE WORK.

At the outset, this limited investigation in cooperation with the Bureau of Entomology, it was necessary to secure the names of as many bee keepers in the state as possible, in order to communicate with them and thereby learn the status of the industry at that time. A report blank asking various questions concerning the apiary, was sent to each bee keeper, whose name could be secured. A list of the publications of the Bureau was also inclosed so that the bee keeper might indicate in which he was especially interested. By this means valuable information was secured, and made possible, a preliminary study of the needs and possibilities of the industry. The desire of the bee keepers for information, was indicated by their request for one or all of the publications of the Bureau of Entomology on Apiculture.

DISTRIBUTION OF BEES IN THE STATE.

From information at hand, it would seem that about 80% of the bees in Maryland are kept on the Western Shore. Of this, 80% on the Western Shore, about 74% are kept in the Northern and West counties. No explanation can be given for this condition, as bees would probably do better in the Eastern and Southern parts of the State, than in other regions. However, this distribution indicates the need of development of the industry and the education of the people to the

opportunities for bee keeping in other sections. Thus far, Montgomery County is the banner county for the bee industry, with Frederick, Garret and Baltimore counties closely following. The distribution in the Western counties is about equal. This distribution explains in part, the occurrence of disease. The Eastern Shore, as far as known, is free of brood diseases, as is likewise Southern Maryland. This is no doubt due in part to the scarcity of bees in those regions.

INCREASE AND LOSS OF COLONIES.

From figures received it seems that during 1908, there was an increase of 33% in the number of colonies, while during 1909 only 16% increase was reported, making an average of 24.5% each year. Practically no difference in figures of increase of colonies can be noted in relation to territory where the bees are kept. The reported winter loss also does not seem to differ in the different sections. From data received, it is believed that most of the winter loss in this State is due to lack of attention, and, in many cases, to ignorance on the part of the bee keepers as to the proper care of a colony prior to wintering. Often too great a quantity of honey is removed, and artificial feeding is seldom practised to make up for the loss. Thus the colony is weakened by a meager food supply, the vitality of the bees becomes greatly diminished and, they are therefore, much more susceptible to cold and dampness during the winter.

This condition is no doubt, also largely responsible for complaints against the wax moth that have been made by so many bee keepers, who have cooperated by giving information concerning their apiaries. It is known that this moth is able to gain a foothold only in those instances where the colony has been so depleted as to render it incapable of overcoming the attack. Moreover, winter loss is often really due to disease having previously weakened the colony. The large number of complaints of heavy winter loss and moth depredation, would indicate that brood diseases are more generally spread in the State than we even now know.

PRODUCTION OF HONEY AND WAX.

Calculating the average pounds of comb and extracted honey per bee keeper of those who have reported, and applying this average to the probable number in the State, the approximate annual production of honey is about 500,000 pounds, of which only about 15% is extracted. This amount does not nearly approximate the quantity of honey used in the State annually, even at the present limited demand in the markets of our cities and towns.

As pointed out previously, this product has not been advertised, directing attention to its usefulness and adaptability to the diet of every day life. It is believed that a larger per cent of honey should be extracted and put on the market in convenient sized bottles, jars and larger containers, such as quarts, gallons, etc. Undoubtedly much of the honey produced in Maryland is too dark to make first class.

comb honey, and the honey flows are slow, which is also not favorable for comb honey production.

As far as known, little or no honey is exported from Maryland. On the other hand, we have definite information from wholesale dealers that quantities of honey are imported into the State from the northern and western states. Even under the present demand, there is great opportunity for the promotion of the industry in the State from the point of view of strict business possibilities alone. Moreover, the total approximated crop of 500,000 pounds in the State is very meager when it is considered that single apiaries in western states often produce from 50 to 100 tons in a year, in locations that are little better for keeping bees than are many parts of Maryland.

The production of bees wax is correspondingly low in the State. Based on an estimate similar to that for honey, the total crop would amount to about 10,000 pounds per year. The common practise of bee keepers to make wax only from old comb, makes the annual production variable. Outbreaks of disease or severe winter losses ordinarily cause an increase in wax output the following year. The commercial value of this product is an additional incentive for increasing the industry in the State.

SOURCES OF HONEY.

Every bee keeper should familiarize himself with the bee flora of his locality. While it is sometimes very difficult to learn the sources from which bees secure their products, yet every effort should be made to ascertain the principal nectar yielding plants of a neighborhood, and the approximate dates of beginning and ending of each important honey flow.

Clovers are considered by far the most important honey plants in Maryland. Of all those reported, the clovers are placed as the principal surplus plants. White clover is the most useful where it occurs in large areas, and the honey secured from this plant ranks high in color and flavor. Alsike clover, which is an excellent nectar yielding plant, is now being grown quite generally in the State. A common practice among farmers in sowing clover for forage, is to mix the different clovers which increases the value of such fields to the bee keeper. Many reports have been received, giving crimson clover as an excellent surplus plant. It is also being more generally grown in the eastern, southern and central parts of the State. While red clover is most commonly grown by farmers and has more or less continuous bloom, it is ordinarily not useful to the honey bee. Sweet clover, which some consider a weed is common along the roadsides in many parts of Maryland, and is an excellent honey plant. Inasmuch as this plant is useful, being a legume, it is worthy of more attention in this State.

Fruit Bloom. The bloom of apple, peach, pear and cherry, is given in the reports as next in importance as honey producing plants. These fruits are common throughout most parts of the State. No surplus

honey is secured from fruit bloom as a rule, but the colonies are stimulated by such early bloom to early brood-rearing.

Buckwheat. This Plant ranks third, according to information received as a surplus plant. This crop is not generally grown except in the western counties.

Locust and Basswood. The black locust ranks high as a yielder of nectar. It is a hardy tree and found commonly over the State. In some sections basswood is still a prominent source of surplus. Like tulip poplar, however, these trees are being largely cut from our woodlands.

Miscellaneous. Goldenrod and asters are reported as important in providing surplus for wintering, while the bloom of sumac, wild raspberry and blackberry are among the more important wild plants that abound throughout the State, that are abundant honey producers. The maples are usually considered as valuable for bees, principally for pollen.

As a rule, too little attention is given by the bee keeper to the honey plants of the locality. A bee keeper should know the principal honey plants of the vicinity, when they come into bloom, so as to manipulate the colonies to obtain the maximum surplus.

The following list of plants constitutes a partial list of the bee flora of Maryland, and their general distribution. Mounted specimens of these plants with dates giving their approximate value as honey plants in northeastern sections of the State, were exhibited at the State Bee Keepers Association in Baltimore, November 30 and December 1, 1910, by Mr. J. Ford Sempers, of Aiken, Md., to whom the writer is greatly indebted. The data given on these specimens has been supplemented by data concerning their range in the State, and their usefulness in other sections.

PARTIAL LIST OF BEE FLORA OF MARYLAND.

Common Name.	Scientific Name.	Date of Flowering.	Apicultural Value.	Distribution in Maryland.
Chickweed. Alder.	<i>Alpine Media.</i> <i>Ainus rugosa.</i>	Feb. and Mar. Feb. and Mar.	Slight value. Early contributory species.	Common Throughout State. Common Throughout State.
Hazel Nut. Red or Swamp Maple. Daffodil. Crocus.	<i>Corylus Americana.</i> <i>Acer rubrum.</i> <i>Narcissus Pseudo-narcissus.</i> <i>Crocus vernus.</i>	Feb. and Mar. Mar. and Apr. Mar. and Apr. Mar. and Apr.	Slight value. Contributory. Slight value. Contributory.	Not Common Throughout State. Common Throughout State and elsewhere. Infrequently cult. Infrequently cult.
Hyacinth. Swamp Pink. Golden Bell. Arbutus.	<i>Hyacinthus oventales.</i> <i>Helonias hulbata.</i> <i>Forsythia viridissima.</i> <i>Epigaea repens.</i>	Late Mar., Early Apr. Mar. and Apr. Apr.	Slight value. Slight value. Slight value. Slight value.	Infrequent cult. Infrequent cult. Common Throughout State. Common Throughout State.
Peach. Cherry.	<i>Prunus Persica.</i> <i>Prunus cerasus.</i>	Mar. and Apr. April.	Important contributory species. Important contributory species.	Common Throughout State. Common Throughout State.
Plum. Missouri Currant.	<i>Prunus domestica.</i> <i>Ribes aureum.</i>	April. April.	Important contributory species. Slight value.	Common Throughout State. Common in Coastal and Midland Zones.
June Berry. American Crab Apple. Cultivated Apple. Cockspur Thorn. Lilac. Dandelion. Pink Azalea. Huckleberry.	<i>Amelanchier canadensis.</i> <i>Pyrus coronaria.</i> <i>Pyrus Malus.</i> <i>Crataegus Crus-galli.</i> <i>Syringa vulgaris.</i> <i>Taraxacum officinale.</i> <i>Azalea nudiflora.</i> <i>Gaylussacia baccata.</i>	April. Apr. and May. Apr. and May. Apr. and May. Apr. Apr. to Oct. May. May.	Slight value. Slight value. Contributory to surplus. Slight value. Slight value. Contributory. Occasionally visited. Slight value.	Cult. Common. Common Throughout State. Common Throughout State. Uncommon Throughout State. Commonly Cult. Common Throughout State. Common Throughout State. Common Throughout State.

PARTIAL LIST OF BEE FLORA OF MARYLAND—Continued.

Common Name.	Scientific Name.	Date of Flowering.	Apicultural Value.	Distribution in Maryland.
Black Gum.	<i>Nyssa sylvatica.</i>	May.	Contributory species.	Common Throughout State.
Clematis.	<i>Clematis Caerulea.</i>	May.	Slight.	Rare Throughout State.
Horse Chestnut.	<i>Aesculus Hippocastanum.</i>	May.	Slight.	Rare Cult. Throughout State.
Wild Black Raspberry.	<i>Rubus occidentalis.</i>	May.	A surplus plant.	Common Throughout State.
Crimson Clover.	<i>Trifolium incarnatum.</i>	May.	A surplus plant.	Common Throughout State.
Quince.	<i>Cydonia vulgaris.</i>	May.	Slight.	Not Common Throughout State.
Blackberry.	<i>Rubus villosus.</i>	May.	Occasionally visited.	Some species of blackberry com- mon all over State. Coastal
Tulip Tree.	<i>Liriodendron Tulipifera.</i>	May and June.	Valuable surplus plant.	Common Throughout State.
Hairy or Winter Vetch.	<i>Vicia villosa.</i>	May and June.	Surplus.	Common Throughout State.
Black Locust.	<i>Rodinia Pseudacacia.</i>	May and June.	Important surplus plant.	Uncommon Throughout State.
Aisic Clover.	<i>Trifolium hybridum.</i>	May and June.	Good surplus plant.	Common Throughout State.
Sumac.	<i>Rhus hirta.</i>	June.	Surplus.	Common Throughout State.
Rape.	<i>Brassica Napus.</i>	June.	Visit sparingly.	Cult. Common Throughout State.
Wild Radish.	<i>Raphanus Raphanistrum.</i>	June.	Visited for nectar.	Rare Throughout State.
Orchard Grass.	<i>Dactylis glomerata.</i>	June.	Contributory.	Common Throughout State.
Borage.	<i>Borago officinalis.</i>	June.	Contributory.	Rare Throughout State.
Grapes.	<i>Vitis (Species).</i>	June.	Slight value.	Common Throughout State.
Magnolia.	<i>Magnolia Virginiana.</i>	June.	Slight value.	Common in Coastal Zone.
Strawberry.	<i>Fragaria Virginiana.</i>	June.	Contributory.	Common Throughout State.
Persimmon.	<i>Diospyros Virginiana.</i>	June.	Surplus.	Common in Coastal and Midland Zones.
Mountain Sumac.	<i>Rhus copallina.</i>	June and July.	Contributory specie.	Common Throughout State.
White Clover.	<i>Trifolium repens.</i>	June and July.	Main surplus plant.	Common Throughout State.
Chinquapin.	<i>Castanea pumila.</i>	June and July.	Occasionally visited.	Frequent Throughout State.
Am. Chestnut.	<i>Castanea dentata.</i>	June and July.	Surplus, poor qual.	Common Throughout State.

PARTIAL LIST OF BEE FLORA OF MARYLAND—Continued.

Common Name.	Scientific Name.	Date of Flowering.	Apicultural Value.	Distribution in Maryland.
Wild Carrot.	<i>Daucus Carota.</i>	July.	Slight value.	Common Throughout State.
Virginia Mint.	<i>Koellia Virginiana.</i>	July.	Contributory.	Common Throughout State.
Buttombush.	<i>Cephalanthus occidentalis.</i>	July.	Frequently visited.	Frequent Throughout State.
Swamp Milk-weed.	<i>Asclepias incarnata.</i>	July.	Contributory.	Frequent Throughout State.
Sundrops.	<i>Oenothera fruticosa.</i>	July.	Contributory.	Common Throughout State.
Peppermint.	<i>Mentha piperita.</i>	July and Aug.	Contributory.	Frequent Throughout State.
Sweet Clover.	<i>Mellilotus alba.</i>	July to Sept.	Surplus.	Frequent Throughout State.
Water Hound.	<i>Lycopus rubellus.</i>	August.	Contributory.	Not Common Throughout State.
Touch-me-not.	<i>Impatiens biflora.</i>	August.	Frequently visited.	Common Throughout State.
Mushmelon.	<i>Cucumis melo.</i>	Aug. and Sept.	Contributory.	Common Throughout State.
Indian Corn.	<i>Zea Mays.</i>	August.	Frequently visited.	Common Throughout State.
Great Ragweed.	<i>Ambrosia trifida.</i>	Aug. and Sept.	Contributory.	Common Throughout State.
Ragweed.	<i>Ambrosia artemisiifolia.</i>	August.	Contributory.	Common in Coastal Zone.
Asparagus.	<i>Asparagus officinales.</i>	Aug. and Sept.	Frequently visited.	Common Throughout State.
Spanish Needles.	<i>Bidens bipinnate.</i>	Aug. and Sept.	Frequently visited.	Common Throughout State.
Day Flower.	<i>Commelina virginica.</i>	August.	Contributory.	Common in Middle Zone.
Buckwheat.	<i>Fagopyrum esculentum.</i>	September.	Contributory.	Common Throughout State.
Goldenrod.	<i>Solidago (Species).</i>	Aug. and Sept.	Contributory.	Common Throughout State.
Aster.	<i>Aster Punicicus</i> and others.	Aug. and Sept.	Yields a light surplus.	Common Throughout State.
Red Clover.	<i>Trifolium repens.</i>	June to Aug.	Contributory.	Common Throughout State.

AVERAGE EXPERIENCE OF BEE KEEPERS, HIVES AND KIND OF BEES.

The average length of time during which the bee keepers who answered inquiries, had kept bees is 12 years. Of those reporting 38% had kept bees less than 5 years. This would indicate that we have a number of amateurs in the business. The great majority reported 8 and 10 years experience, while many reported keeping bees for 15 to 20 years. Of those reporting 68% kept Italian bees, which is a good sign, as it is believed that this is the most profitable and satisfactory race of bees to keep for Maryland conditions. It is not believed that all reporting Italian bees meant to report pure stock, but it shows a large per cent of good conditions. Moreover from this data it is found that about 80% of the bee keepers are using up-to-date frame hives. These conditions account for the good average of 30 pounds of honey per colony per year that these records show.

BEE DISEASES IN THE STATE.

While funds have not been available to conduct a thorough investigation into the conditions of the apiaries of the State, yet through the cooperation of the Bureau of Entomology, we have been able to learn that the two diseases, European and American foul brood exist in several counties in the State. While these diseases will be discussed later on in this bulletin, it may be stated that these infectious diseases, where established, are disastrous to the apiary if steps are not taken to eradicate them.

There is no more dangerous menace to the industry than neglected apiaries infected by these diseases in a neighborhood where healthy bees are kept. Moreover, unless measures are adopted to prevent their spread, ignorance or neglect on the part of the owners, of apiaries will certainly reduce, and perhaps annihilate an already neglected industry of the State.

THE NEEDS OF THE INDUSTRY IN MARYLAND.

Briefly it may be said that the majority of Maryland bee keepers need education in up-to-date methods of bee keeping. The remaining old box hives must be replaced by movable frame hives. The apiaries of the State should be inspected for the presence of infectious diseases and those keeping neglected hives should either be made to abolish them, or to give the bees attention and keep them in a healthy condition. Funds should be provided for instruction, investigation, and extension work by the State institutions, and legislation should be enacted such as now exists in twenty-six other states and territories for the protection and the promotion of the industry.

Maryland offers excellent natural advantages for the development of the beekeeping industry and it only remains for the beekeepers themselves to practise more up to date and scientific methods in the conduct of their apiaries and to secure the adoption of proper legislative measures to insure the State a more prominent rank in the production of bee products.

BEE KEEPING IN MARYLAND.

II. THE MANAGEMENT OF BEES.

By ARTHUR H. McCRAY, D. V. M.

Apicultural Assistant, Bureau of Entomology, U. S. Department of Agriculture.

Beekeeping for profit has within comparatively recent years assumed such exactness of methods compared with former times, that discussions of methods and appliances used in commercial bee keeping have followed quite naturally and are always in order for additional enlightenment. It is not the aim of this paper to discuss the merits of any particular system of management but to give simple working directions for the establishment and maintenance of a comparatively small apiary.

The methods to be used in bee keeping are determined to a certain extent by locality, and consequently vary for different sections of the country. While it is doubtless true that the importance of locality has been somewhat overestimated, it should not be ignored. This bulletin has been prepared particularly for the bee keepers of Maryland and the aim has been to make the directions and discussions herein given, particularly applicable to Maryland conditions.

As a rule, one should not start bee keeping except in a small way. The uncertainties of securing a honey crop are many and varied. As examples of the causes of failure, the following may be cited: the failure of the honey flora to secrete nectar; the inability of the bees to gather the nectar when secreted, owing to unfavorable weather conditions; the failure of the beginner to do the right thing at the right time; and last but not least the danger of losses from disease.

From the above it will not be surprising to learn that many disasters have occurred with beginners in bee keeping. It is, of course, all the more deplorable if the first investment has been too large. The beginner with a moderate investment, is more apt to recover from his early failures, than is one who has had too much at stake. Four or five hives are generally sufficient for the first season. These can be increased when the returns from the honey and wax are sufficient to pay for additional empty hives and other equipment. It is a good plan for the beginner to make the bees pay for the increased equipment, and produce some profit in addition. Probably nine out of ten, who make a failure of bee keeping, try to manage too many colonies without previous experience or knowledge.

From the small bee keeper develops very often the specialist bee keeper, and the aim should be to make better bee keepers of those already engaged in the industry rather than to increase the number. There is no reason, however, why every intelligent farmer should not keep a sufficient number of colonies of bees to furnish honey for his own use.

Bee keeping is usually carried on in conjunction with some other

business. There is no reason, however, why it should not be made the sole means of livelihood. There are in the United States today, many men who devote all of their time to their bees, and find it a remunerative business.

With the improvement of the modern movable frame hive, together with the perfecting of systems of management, and a sufficient knowledge of the business, gained by study and experience, the opportunities of the specialist bee keeper, were never better than they are today.

The writer wishes to acknowledge his indebtedness to Dr. E. F. Phillips, in charge of Apiculture, Bureau of Entomology, U. S. Dept. of Agriculture, for valuable suggestions in the preparation of this bulletin and for the privilege of using many of the illustrations from Farmer's Bulletin, No. 447. Acknowledgements are also made to the A. I. Root Co., Medina, Ohio, for the use of cuts for figures 6, 12, 21, and 23.

BEE BEHAVIOR.

Every normal colony of bees in the active season consists of three kinds of individuals, (fig. 1.) the queen, a variable number of drones, and several thousand workers. The queen is the only fully developed female in the hive, and is the mother of all of the other bees. The

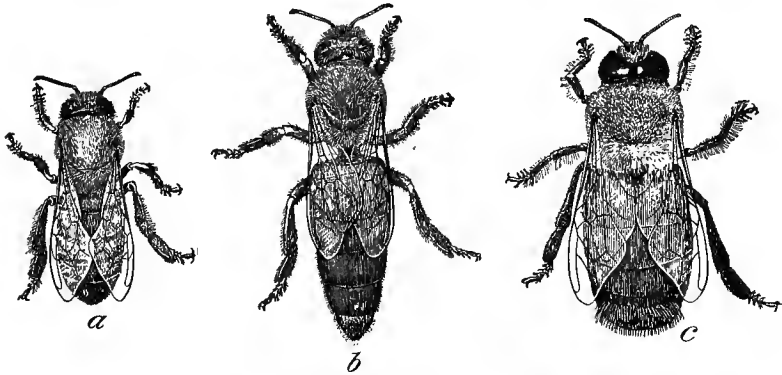

Fig. 1.—Worker, queen and drone.

drones often number several hundred and are present in the hive at or near swarming time in largest number. Their sole function is to mate with the virgin queen. Towards fall the drones are destroyed by the workers, usually by being forced from the hive, where they die of starvation. The workers constitute the largest part of the colony, and in a good sized colony number 40,000 to 70,000.

The workers are sexually undeveloped females. They perform all the labor of secreting wax and building comb, feeding the young, protecting and cleaning the hive and gathering and storing honey and pollen.

The honey comb (fig. 2.) in which all honey and pollen is stored, and the young brood reared, is built by the worker bee from wax which is secreted from the under side of its abdomen, in the form of very small thin flakes. These flakes are manipulated by the mandibles of the bee and moulded into the various forms required in building the comb. The comb consists of hexagonal cells arranged on the two sides of a vertical septum, or mid-rib.

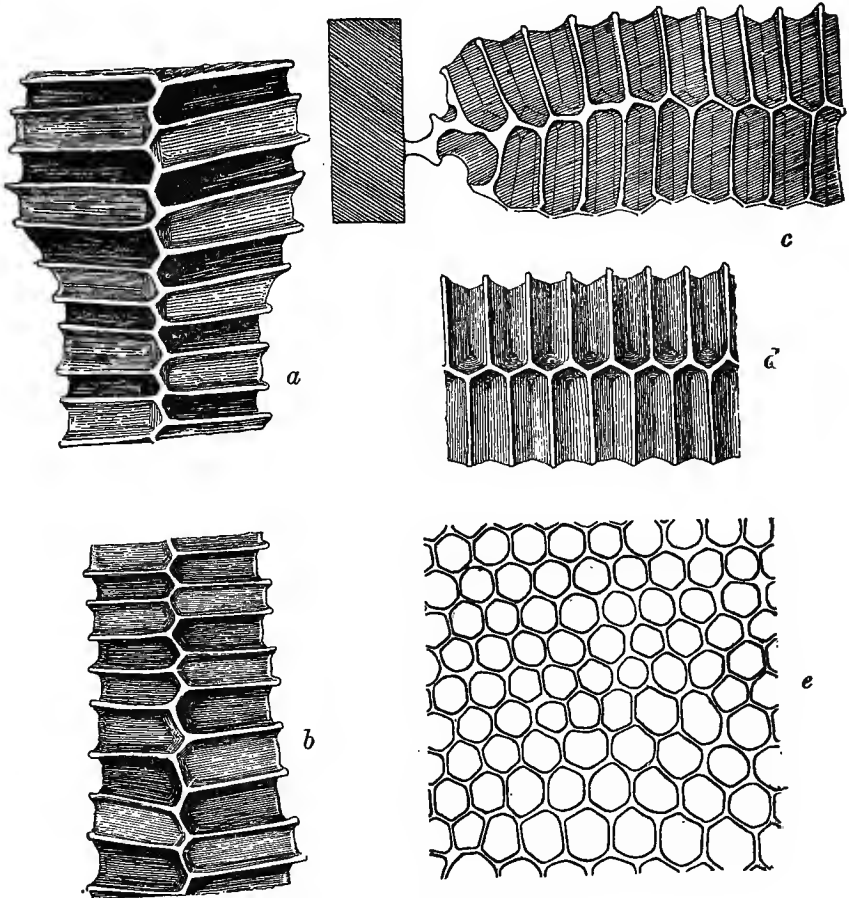

Fig. 2.—Comb architecture.

Two sizes of cells are easily recognizable, viz. that in which the worker bees are reared, which is $\frac{1}{5}$ inch in diameter, and that in which the drones are reared, which is $\frac{1}{4}$ inch in diameter. There are also irregular transition cells where these two sizes merge into each other. Any of the cells may be used for storage.

The eggs (fig. 3.) as laid by the queen are deposited on end at the bottom of the cell. In about three days the larvæ (fig. 3.) hatch, and are fed by being surrounded with liquid nourishment for about six days, when the cells are sealed over and the larvæ spin a cocoon and undergo a metamorphosis in which they are transformed into the adult bees, which emerge in about 21 days from the time the eggs are laid. The time of emergence varies for queens and drones. The

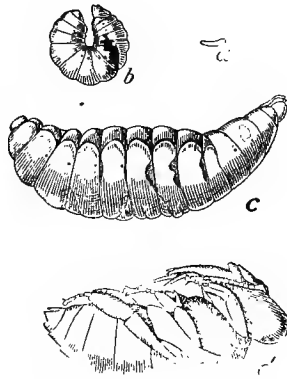

Fig. 3.—Egg larvæ and pupæ.

period of the former is about 16 days, and of the latter about 24 days. The greatest number of eggs are laid by the queen during the season when nectar is being brought in, when all bee activity is at its height. Towards fall the queen lays fewer and fewer eggs, until in the months of September or October, often few eggs or little brood can be found in the combs. After a more or less inactive condition, including diminished brood-rearing through the cold of winter, the bees begin preparation for spring activity. Just at what time the queen begins active laying in the spring, varies considerably according to strength of colony, amount of stores, protection of the hive, etc.

With the advent of the warm days of spring, and the opening of fruit bloom and other flowers, the colony rapidly increases in number of inhabitants, until the hive will no longer accommodate the increase and swarming is the result. The first swarm of the season, is accompanied by the old queen and a share of the worker bees. Previous to swarming, preparations are made by the bees for a new queen for the parent colony. This provision for the old parent colony consists in building queen cells, (fig. 4.) These are developed from young female larvæ by feeding them a specially prepared food. Normally the young queen does not emerge for several days after the swarm has issued with the old queen. If, however, the weather should be unfavorable, the young queen may emerge from the cell before the swarm with the old queen issues. Besides this first swarm accompanied by the old queen, there are often several smaller swarms, which issue after the first one. These after swarms are accompanied by one or more of the young virgin queens.

On or after the emerging of the first queen, the remaining queen cells are usually destroyed. This is not always done, however, and hence the issuing of several small swarms (after swarms), subsequent to the first or prime swarm results. The swarm after issuing, if not taken care of by the bee keeper, seeks a home in some hollow tree or elsewhere. The parent colony acquires strength from the brood left by the old queen, and later from the progeny of the young queen, which emerges from one of the queens cells built under the swarming impulse. The young or virgin queen, before she becomes the mother of the colony, must first meet the drone or male bee and become mated. This takes place outside of the hive, and in flight and probably occurs only once in the lifetime of the queen. After mating, the young queen returns to the hive and in a few days takes up her duties as the mother

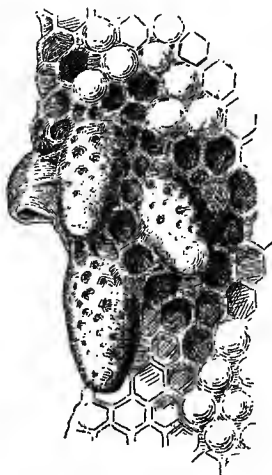

Fig. 4.—Queen cells.

of the colony. Eggs from which drones are hatched are not fertilized by the queen, i. e., they do not receive any spermatozoa, or male sex cells, as do the worker eggs. This is what is known as parthenogenetic development. A young queen on failing to mate with the drone will sometimes start egg laying. These hatch only drones. Sometimes when a colony is deprived of a queen for a long time, the worker bees, being undeveloped females, will start egg laying. Such eggs also hatch out drones. An old queen will sometimes lay eggs, which hatch drones only probably because of exhaustion of her supply of spermatozoa.

This is only a very brief outline of some of the activities of the hive. A knowledge of bee behavior is essential to the successful handling of bees, and the bee keeper gradually acquires a few principles, which he unconsciously applies in working with the bees. Far too little is

known of this subject and its application in the manipulations of the apiary.

EQUIPMENT OF THE APIARY.

HIVES.

The kind of hive, providing it is of simple construction with movable frames, is not so important as is the method of handling it. Most of the honey produced in the country today, is taken from hives, that embody the main features of the Langstroth hive invented in 1851. This consists of a plain wooden box, holding eight or more frames

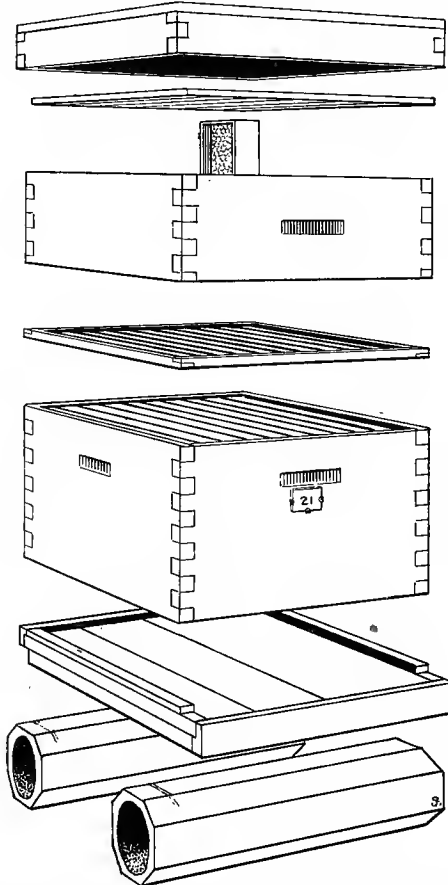

Fig. 5.—Ten frame hive with comb honey super, excluder and perforated zinc queen.

hung from a rabbet cut in the inside of the wall of the hive near the top. The Langstroth frame is $9\frac{3}{8} \times 17\frac{5}{8}$ inches. The modern hive is an improvement in that the wooden box has been much strengthened by the dovetail or interlocking corners (fig. 5.) Further improvement

is secured by the use of a metal rabbet, which lessens the area of contact with the frames and so reduces the amount of propolis deposited between frame and rabbet. The eight and ten frame hives are in general use. Some use larger hives of twelve or fourteen frames, claiming that swarming is thereby reduced. Such hives are however, unwieldy to handle, and there are other efficient methods of controlling swarming.

Some bee keepers are advocating the use of a frame of about half the depth of the Langstroth. These are to be used as supers for the storing of the surplus, as well as for the brood chamber for the rearing of the young bees. Two or more bodies are required for the use of the queen as a brood chamber. The use of such shallow frames permits, to a large extent, of the handling of bodies rather than frames. The queen can often be found by smoking the bees from these shallow bodies, after which the operator can look up between the frames from the bottom and see the condition of the brood chambers as to stores and brood. (fig. 6.) It is believed that bee keepers can profita-



Fig. 6.—Looking up between frames.

bly try this style of hive. Whatever style of hive is used, the bottom board and cover should be detachable and not nailed fast to the hive body. Much information concerning hives and fixtures can be secured from catalogues of dealers in bee supplies.

HIVE STANDS.

All hives should be raised from the ground far enough to keep them from rotting. This may be accomplished by setting them on bricks, flat stones, etc. Six-sided hard burned tile (fig. 5.) placed crosswise

at the front and rear of the hive have been found efficient. A cheap hive stand can be secured by hewing round sticks of wood on one or two sides, and using them in the same manner as the tile.

TOOLS AND OTHER APPARATUS.

Among the necessities of any apiary, large or small, are a good smoker (fig. 7.) to subdue the bees, and a veil, (fig. 8.), of some light material to protect the face. Some sort of tool for separating bodies

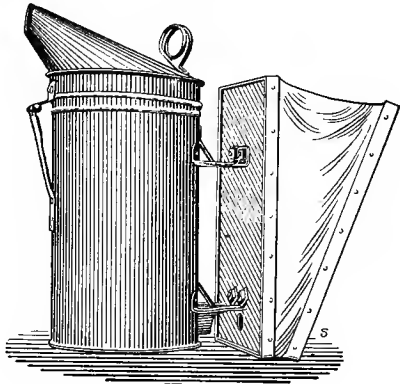

Fig. 7.—Smoker.



Fig. 8.—Veil.

and frames, and for scraping propolis and bits of wax from hives and fixtures is desirable. The ones figured have been found satisfactory (fig. 9.). Queen cages of which there are many kinds in use, will be found indispensable. Foundation fasteners, feeders, (figs. 16, 17, 18,

19,) drone traps, (fig. 20.) and honey boards of perforated zinc (fig. 24.) are almost equally as indispensable, not to mention such other desirable apparatus as division boards, swarm catchers, bee

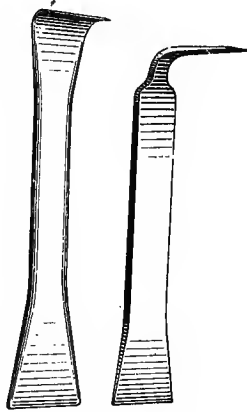

Fig. 9.—Tools.

brushes, (fig. 10.), wax extractors, etc., etc. All of this apparatus is amply described and figured in catalogues of supply dealers.

HONEY HOUSE AND SHOP.

The honey house should be quite near to the apiary for convenience in handling supers full of honey when taking off the crop. It is not desired to say a great deal concerning a honey house, except to urge



Fig. 10.—Bee brush.

the desirability of every bee keeper, providing some such place where empty hive bodies and supers and all other tools and apparatus can be kept and easily found when wanted. The section honey must be scraped free of propolis and packed, and the extracted honey thrown from the combs, and it is better to have a small building especially for this purpose. The honey house need not be expensive, and it will certainly facilitate the work of the apiary. A shop where hives and fixtures can be put together, and where other work requiring the use of tools can be performed, is indispensable. The honey house can be made large enough for this purpose.

BEES.

Usually the cheapest way for the beginner to acquire bees for the apiary, is to purchase a few colonies near home. There are often black bees near at hand in box hives, or antiquated frame hives, which can usually be purchased at small cost. These can be bought in the fall and wintered. It is better however, to purchase in the spring, and reduce chances of winter loss. These are to be transferred when fruit bloom opens. The race of bees purchased matters little as the bee keeper can introduce a queen of whatever race of bees he desires in the spring, and soon the whole colony will consist of the offspring of the newly introduced queen.

This is due to the fact that during the height of the honey gathering season, the tasks of the worker bees are so arduous that their life period is quite short, and as they die their place is taken by the progeny of the recently introduced queen. If bees cannot be secured near at hand then one or more nuclei (small colonies) of two or three frames each can be purchased of a dealer. These can sometimes be increased to several full sized colonies during the course of the season.

Of the several races of bees maintained by bee keepers at the present time, the beginner will probably find the Italians most satisfactory. This race is the equal of any in nectar gathering ability and actively resists the ravages of wax moths. Italian bees are gentle and easily handled, and they have received far more attention from breeders than any other race. This is not saying however, that other races are not worthy of equal attention with a view to improvement. There are on the market today so called Red Clover queens, whose progeny are supposed by some to possess tongues of sufficient length to reach the nectar in the blossom of the red clover plant. While these bees are usually good honey gatherers, the results secured by their use, would scarcely warrant such a descriptive term as "long tongued" or "Red Clover" bees. The Italian race of bees has also been bred for color, so that three, four, and five, yellow-banded strains are now in use. It must be borne in mind, however, that color marking is of secondary importance, and that honey gathering proclivity is the first consideration. Utility should not be sacrificed for ornament.

Caucasians have been used to some extent, perhaps largely because of their gentleness and ease of handling. They are good honey gatherers and quite prolific. The queens are however dark and sometimes small, and hence difficult to locate on the combs. This race also collects great quantities of propolis, and builds a large amount of brace and burr combs, factors which are not conducive to easy and rapid handling of frames.

The Cyprians have been almost universally ruled out because of their fierce stinging proclivities.

The Carniolians are very gentle, but swarm excessively and are not much used.

Other known but little used races are the Banat, "Holy land," Egyptian and Punic. Of these four last named, the Banat is most used and is looked upon with favor by some breeders and honey producers.

The black or German bee was the first race introduced into this country, and is still abundant usually as a cross with other races. The black bee is not desirable and is being gradually supplanted by other and more desirable races.

THE APIARY: ITS LOCATION AND SIZE.

While there are certain ideal sites for the location of the apiary, which should be utilized if possible, yet bees can be kept in a great many places which do not conform to ideal surroundings. A slope gently inclining to the south and east is very desirable, although any plot of ground that has good drainage, so that water does not stand on it, is good. The slope to the south and east secures protection against cold winds from the north and west, although this advantage can be as well and even better attained, sometimes, by other barriers, such as a grove or fruit orchard. Buildings of some kind can often be made to serve this purpose, as the honey house and shop.

The hives should not be too near walks or drives, owing to danger from stings. This is particularly applicable if horses that are perspiring are likely to be brought near such driveways.

It is considered best to face the entrance of the hives south or east, or somewhere between these two directions. This will give the bees the early morning sun and start them gathering nectar early in the day. While it is desirable to have a certain amount of sun, particularly in the early part of the day, this may be a source of discomfort and actual loss if hives are unshaded at the hottest part of the day. The midday and afternoon sun when beating down on unprotected hives may be so severe as to melt down the combs within the hive. The result of such a disaster is obvious. Perhaps the ideal location as far as providing shade is concerned, is under trees that have the branches high enough not to interfere with easy movements of the operator when attending to the hives. The comfort of the bee keeper is to be considered as well as the welfare of the bees. One is more apt to give the bees the attention they need, if the work can be done in the shade, rather than under the rays of the sun at the most heated part of the day.

The hives should be level from side to side in order that the combs may be built straight. If the hives were inclined to one side, it would result in the newly drawn comb, being swung from the top bar of one frame and attached to the bottom bar of the frame adjacent, since comb building progresses from above downward. The hives should, however, slope downward from the rear to the front. This will cause any rain, which may beat in and any moisture which may condense on the inside of the hive to run out at the entrance.

The hives can be arranged to suit the convenience of the operator in manipulation. Ample space should be allowed for ease of movement. A good arrangement consists in setting the hives in rows. (fig. II.) A line may be used to get the rows straight.

As to the covering of the ground, whether bare or sod, it is believed that grass is much more preferable as it facilitates the ease and pleasure of working in the apiary. No grass or weeds, however, should be

allowed to grow up at the entrance of the hive. A lawn mower can be used to good advantage in keeping the grounds in and around the apiary in good condition.

As before said, the above are more or less ideal conditions. Bees can be kept in a great many places with profit that are far from conforming to the above conditions. City people even manage to keep bees by setting them out on the roof or a back porch where the line of flight is clear so that there is no danger of interfering with neighbors.

The size of the apiary will depend on various factors, chief among which will be the time and inclination of the bee keeper, and the natural flora present, from which the bees may gather nectar. The number



Fig. 11.—An apiary in Maryland.

of colonies of bees which a given locality will support will vary, and the beginner as he gradually increases his colonies from year to year, must determine the point at which he must cease increasing at the home yard and begin the establishment of out apiaries.

It is believed that it is best to err on the side of too few colonies, rather than too many, although there is some reason for believing that the number of colonies which may be kept in one apiary has often been underestimated.

If the bee keeper is not yet willing to give all of his time to the bees, then the home yard may be crowded so that 100 or 125 colonies may be maintained there under Maryland conditions. But if practically all of the time is to be devoted to the bees, it might often be better to establish out apiaries maintaining only about 50 colonies in a yard.

The distance to which bees will fly for nectar has been variously estimated at from 1 to 3 miles depending on the amount of nectar near at hand, or limitation of range due to some natural barrier as a body of water, mountain, etc.

The keeping of bees all in one large apiary has the advantage and certainly is to be practiced whenever the resources of the surrounding country will warrant it. With only one yard, there is economy in providing honey houses, tools, and often in transporting the crop after harvesting.

TRANSFERRING: GENERAL MANIPULATIONS.

The first attempt in the handling of bees will probably be the transferring of the colony or colonies purchased in the old box or antiquated frame hives to modern movable frame hives. It will be assumed in giving directions for transferring, that little or nothing is known of the handling of bees and directions for general manipulations will be incorporated in the directions for transferring rather than devoting a separate paragraph to this subject.

Beginners should always protect the fact with a veil and have the smoker within easy reach. The old hive from which the bees are to be transferred is lifted from the stand and the new hive body with frames, containing full sheets of foundation is set in its place. Full sheets of foundation of worker size cell base will insure straight even frames of worker cells. This should be strengthened by wiring. Avoid rough handling, and quick movements, especially if the bees have not been subdued by the use of the smoker. After bees have been partly subdued by the smoke, the hive may sometimes be jarred about to advantage causing the bees to further gorge themselves with honey until they become quite tractable. If the old hive is a plain box without frames, it must be inverted. If the bottom is nailed fast, it or one side must be removed. Set a tightly fitting box over the exposed side, and by beating on the old hive, (fig. 12.), the bees are made to enter the empty box, after which it can be removed and the bees shaken out at the entrance of the new hive. The bees should not be shaken on the ground, but provided with a runway consisting of a board the width of the hive or greater. This should slope gently upward from the ground to the hive entrance. As the bees are shaken onto this board, the queen can often be seen entering with the other bees. The operation will not be successful unless the queen enters the new hive, since the bees will not remain without the queen even though they all pass into the new hive. The bees must be repeatedly drummed from the old hive until the queen is secured. The bees will not remain longer than a half hour or so in the new hive without the queen and this will serve as an indication to the operator whether he will need to repeat the drumming. The cover should now be lifted from the new hive to note whether the frames are properly spaced. This only applies to frames without a self-spacing device. It is probably better for the inexperienced bee keeper to have frames which will space themselves when forced together one against the other. These are termed self-spacing frames.

The old hive should now be turned right side up and moved some distance away. Allow it to remain here for 21 days, when all of the brood will have hatched and emerged as young bees. These are to be drummed as before and united with the new hive, first, thoroughly smoking both hives to prevent fighting. If the first or old queen is the one desired, the entrance of the new hive should have a piece of queen excluding zinc fastened at the entrance



Fig. 12.—Drumming bees from old hive.

to exclude the young queens. The plan generally followed, however, is to disregard the young queens, by allowing them to enter and the bees to determine the choice of queen. Old combs will usually be found to be so crooked, or so old and black, that they are fit only to be cut out and rendered into wax. They can be saved, however, by cutting out the more regular portions and fitting them into empty frames, securing them by passing cord or rubber bands around the frame, after

which they may be used for hiving swarms or for the storage of honey for extracting. Also the old combs with brood and stores is sometimes cut out and fitted into frames as above described, at the time of the first transferring, instead of setting the old box hive away for 21 days. These frames are then set in the new hive, the bees are shaken in and the transferring is completed at one operation. It is believed that the first described method will prove most satisfactory.

The opening of fruit bloom in the spring is the best time of the year for transferring, although it can be done at any time that nectar is being gathered. It can even be done when there is nothing coming in from the field, provided the bees are fed daily after transferring.

It is best to select a warm, bright day when the bees are flying freely as they can be much more easily handled then. On cool, cloudy days and early and late in the day, bees are usually much more difficult to handle, and are more inclined to sting.

The bees in the new hive should be examined from time to time to determine progress made in comb-building, and in the laying of eggs and rearing of brood.

One should learn from the first how to open a hive and examine frames without unduly exciting the bees. Always stand at one side, out of the line of flight of the bees, (never in front of the hive). First use the smoker at the entrance, then quietly remove the cover, so that it does not come away with a jar. As the cover is lifted, gently blow some smoke over the tops of the frames, after which they can be re-

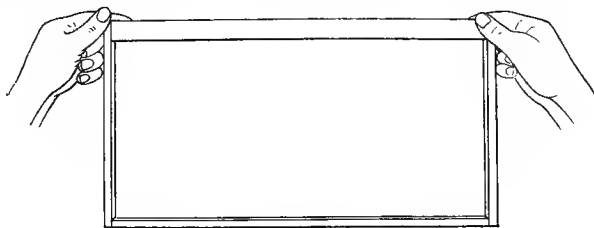

Fig. 13.—Handling frame 1st position.

moved one at a time. If at any time the bees show an inclination to sting while the colony is being manipulated, more smoke may be blown down between the frames. In examining frames, always hold the comb in a vertical position, otherwise it is apt to be broken from its attachments owing to the weight of honey and brood. As the frame is lifted from the hive by the ends of the top bar, one side will be exposed to view. To observe the opposite side, lift the frame as shown by the illustration, until the long instead of the short axis is perpendicular, (fig. 13.) and rotate the frame as a door is swung on its hinges, using the top bar as the axis (fig. 14.) The frame can then be lowered with the top bar below, (fig. 15.) This whole manipulation is easily acquired and if the precaution above mentioned of preserving the face of the comb perpendicular instead of flat wise to the ground is observed, no danger of the comb breaking in the middle will result. As the frames are being removed from the hive, the first one or two can be

leaned against the outside of the hive. This will permit of space for easy movement in handling the remaining frames, which can be placed to one side as they are examined in succession. After the last frame has been examined, the frames can be lifted over to position and the one or two leaning against the outside of the hive returned to their place.

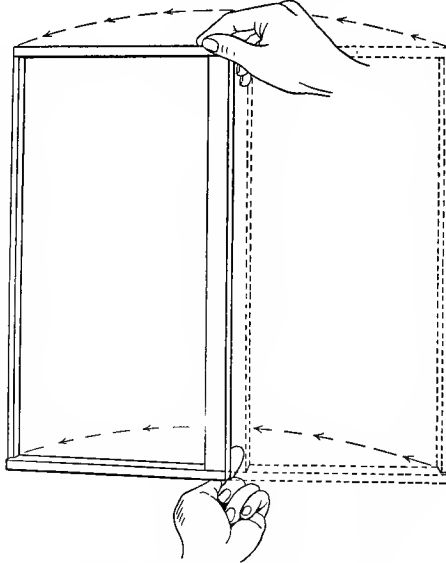

Fig. 14.—Handling frame 2nd position.

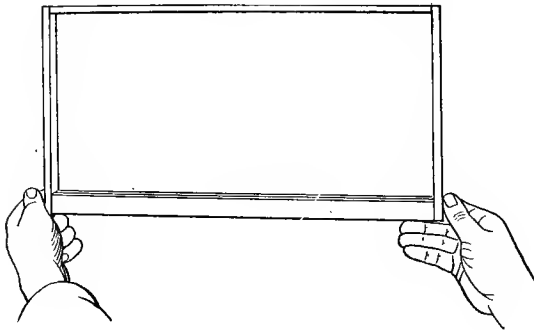

Fig. 15.—Handling frame 3rd position.

UNITING.

It will be desirable at times to unite colonies for various reasons. While some of these reasons are sufficient to justify the operation, yet owing to the difficulty of successful uniting it should usually be resorted to only when the weakened colony can not be built up by feed-

ing. Colonies that are queenless quite early in spring or late in fall can be profitably united. Uniting can be done by setting the colony to be united over the one to which it is to be united. Another method is to lift the frames out separately and shake the bees at the entrance of the colony selected to receive them. In all uniting operations smoke all colonies thoroughly, and cage the queen to be saved for two or three days afterwards, to prevent her being killed by the strange bees.

SPRING MANAGEMENT.

In order to secure the available nectar from the flowers it is necessary to have a large force of bees of the right age in the colony when the honey flow begins. Colonies with bees in sufficient number and of proper age are assured only when given proper attention by the bee keeper. Various factors operate to reduce the strength of the colony through the winter and early spring. So called "spring dwindling", results when the bees are allowed to pass through the winter with too large a force of old bees. These die very rapidly in the spring so that the brood does not emerge rapidly enough to maintain the colony strength. An induced prolongation of brood rearing in the fall will often prevent this trouble. The amount and kind of stores which are available to the bees, through the winter and early spring months, determine largely their condition for the honey harvest. The stores collected in the fall are not always suitable for maintaining the bees in the best of condition during the winter. The secretions deposited by plant lice on foliage and collected by bees is unfit for winter food. This is popularly known as honey dew honey. Other products such as juice from various fruits, or thin improperly ripened nectar, to the exclusion of good well ripened honey, may result in positive injury to the bees, causing what is known as "dysentery." This disease is manifested by the bees spotting the outside and inside of the hives including combs, with a yellow discharge. This trouble usually disappears after a day sufficiently warm to permit of a cleansing flight by the bees.

FEEDING.

Enough stores may be provided in the fall to maintain the bees until the beginning of the honey flow without giving them additional supplies.

Very often, however, good results are secured by stimulative feeding, in the spring. This consists in giving each colony daily a small quantity of feed. This feed may be made by mixing granulated sugar and water, using about two or three parts water to one part sugar. This seems to act much as a flow when honey is daily brought into the hive. This results in early brood-rearing, securing the large field force required to gather the nectar when the flow begins. Of the feeders used for early spring feeding the division board feeder (fig. 16.) will probably be most satisfactory, as it is lowered into the hive just as a frame, and consequently receives warmth from the cluster. The

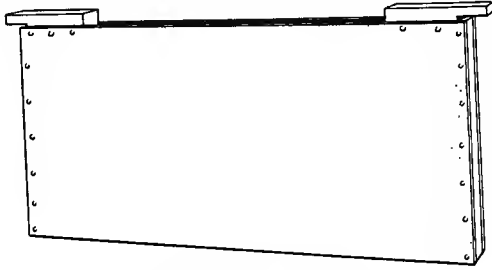

Fig. 16.—Division board feeder.

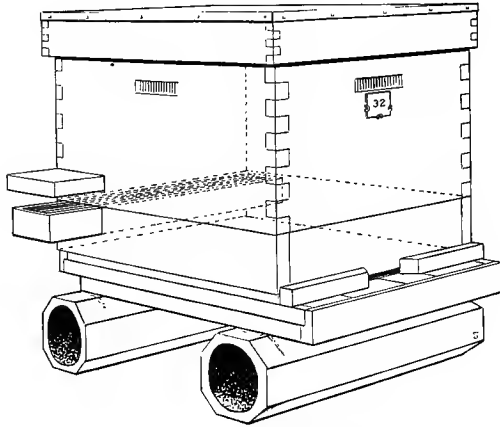

Fig. 17.—Alexander feeder.

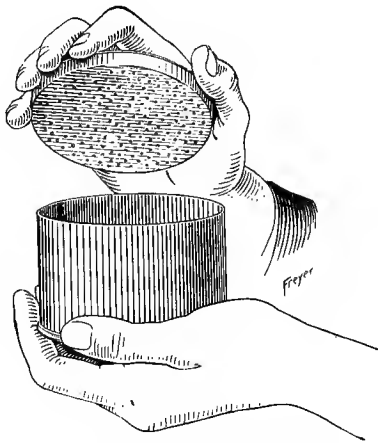

Fig. 18.—Pepper-box feeder.

Alexander feeder fitted in a wooden collar at the rear of the hive may be used. (fig. 17.) This has the advantage of not requiring exposure of the colony in replenishing the feeder. The pepper box feeder consists of a metal cylindrical box, with a perforated cover and is inverted over the frames in an empty super. (fig. 18.) This can be used for spring feeding if the super is packed with a chaff cushion or blankets. A good feeder can be made by setting a pan filled with syrup in an empty super. (fig. 19.) Stimulative feeding in the spring will usually yield large dividends in added returns at the time of harvesting. The best time in the day for feeding is towards evening, when the bees will not have time to start robbing, which often results after feeding, particularly if syrup has been carelessly scattered about.

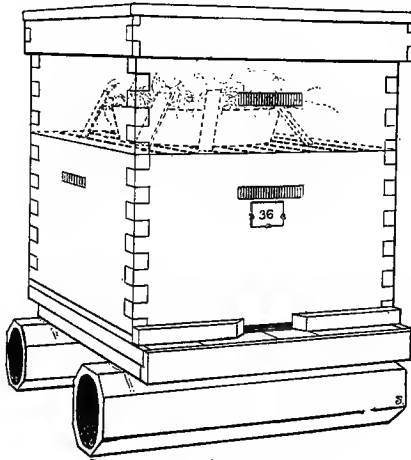

Fig. 19.—Pan feeder.

There will always be colonies that contain a large amount of brood compared with others. Frames of brood can be taken from these strong colonies, to aid the weaker ones. By judicious manipulation of frames in this manner, all colonies can often be increased to about uniform strength for the honey harvest.

Colonies can also often be advantageously stimulated to increased brood-rearing by resorting to what is termed "spreading the brood." This consists in inserting an empty comb between two frames already containing brood. The bees attempt to cover the brood thus enlarging the cluster, and the queen will lay in the empty frame. This procedure should not be undertaken while the weather is unsettled, because a few cold days following a warm period will result in the bees contracting the cluster and the brood which has been lifted to one side is left outside of the cluster where it perishes.

There will always be colonies that appear in the apiary in spring in a weakened condition. Such colonies should be carefully fed and contracted so that they will not be forced to attempt to keep a whole brood chamber warm. Such contraction of the brood chamber can

be accomplished by leaving only a sufficient number of frames as will enable the bees to form a compact cluster, filling the whole available space. The space at the side of the hive should be filled in with a chaff cushion, or a dummy packed with sawdust or some similar materials. The entrance also should be sufficiently contracted.

It is believed that weak colonies are best taken care of by being built up to strong colonies by feeding and contracting. However, if for any reason this is not desirable, the weak colony may be united to a stronger colony by being set over it. Smoke both colonies first, and cage the queen desired, if each colony has a queen. This plan can be used to save a colony that is queenless in early spring.

SWARMING.

Stimulative feeding and other operations for increasing the strength of colonies tend to bring on swarming as the season progresses. Other factors influencing the time of swarming are locality and seasonal variation. The causes operating to induce swarming, are not sufficiently known. Reasons that seem to be sufficient to explain swarming at one time are insufficient at other times. It would seem that if the bees increase to such an extent that the colony becomes crowded and overheated swarming is very often apt to result particularly if a honey flow is on.

Reference has been made previously to the use of large hives as a means of controlling swarming. Lack of sufficient ventilation as a natural accompaniment of an overcrowded condition of the colony, may be partly responsible for the issuance of a swarm. Swarming can be controlled, but cannot be prevented.

Swarming may be profitable by yielding returns in an increase in the number of colonies if this is desired. On the other hand it may be a means of actual loss to the bee keeper, in reducing the honey yield. This will be understood when it is realized that a colony that divides its force by swarming in the height of the honey flow, can be made to yield only a part of what it would have, had it not swarmed. Moreover there is the additional labor required in taking care of the swarm which is a considerable item.

CARE OF SWARMS.

One of the first steps to be taken in swarm management is that of clipping the wings of the queen. This can be done by holding the queen between the thumb and the index finger of the left hand, and cutting off the wings of one side with a sharp pair of scissors. Some think that the queen is better able to maintain her balance on the combs if the wings are cut on both sides. When the swarm issues, the queen being unable to fly is left behind, and is usually found crawling around near the hive entrance. Because of the absence of the queen, the bees will return in a few minutes, unless by chance they have a virgin queen. The old hive is now moved to one side and a new one containing full sheets of foundation is put in its place. The queen is

put in a wire cloth cage and placed at the entrance. As the bees return on finding the queen absent from the cluster, the cage is opened and the queen allowed to enter with the other bees. The returning field bees from the old hive which has been set to one side will also return in greater number to the new hive on the old stand. If there were any surplus honey supers or extracting frames on the old hive they should now be transferred to the new hive, putting a piece of queen excluding zinc, (fig. 24.) between brood chamber and surplus honey to keep the queen below.

If it is not desired to clip the wings of the queen an Alley's queen and drone trap may be placed at the entrance, (fig. 20.) As the swarm

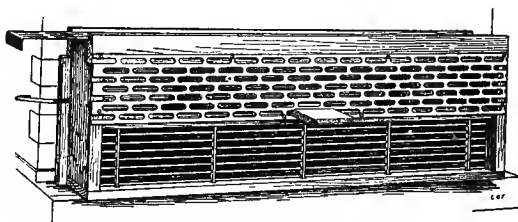

Fig. 20.—Alley's queen and drone trap.

issues the queen is engaged in the trap where she may be found and the swarm is disposed of as above described.

When the swarm is allowed to issue without securing the queen it usually clusters on a branch of a tree near at hand, where it remains for a varying period of time. In this case the branch can be cut away and the bees carried where they are wanted, or the hive can be brought and held under the branch, which is then jarred, causing the bees to fall into the hive held to receive them.

SWARM CONTROL.

While the clipping of the queen's wings, and other methods of preventing the queen from joining the swarm are means of controlling the swarm after it issues, they are not attempts to curb the swarming impulse. The need of ventilation and addition of supers, etc., in preventing overcrowding have been mentioned. A large force of bees is only desirable as the rush of the honey flow comes on, for after this they become consumers, not producers. Moreover it is possible that if eggs are laid and brood reared, up to and including the time of the honey harvest, excessive swarming may result where otherwise it might have been lessened and largely prevented by restraint of the queen. This can be done either by removing or by caging the queen for a time. As a rule, however, the queen should not be too much restrained, and the excess of brood in the hive can often be used to advantage in strengthening weak colonies.

ARTIFICIAL SWARMING.

Instead of waiting for the bees to swarm of their own accord, the bee keeper may practice artificial swarming or what is termed "shook swarming." When properly done, this may be made an efficient means of controlling natural swarming. The procedure is as follows: Watch all colonies for the first preparations for swarming as manifested by the starting of queen cells. As soon as this is noticed, shake most of the bees from the combs into a new hive which has been placed on the old stand. The new hive may be provided with either starters or full sheets of foundation as desired. The full sheets are probably better as a greater amount of worker comb is insured, while if starters are used there is in a great many cases more or less undesirable drone comb built. After shaking, the old hive with brood and the few bees that remain is moved to a new location, and allowed to increase again to a full colony or the bees may be later added to the shaken swarm. Bees thus shaken into a new hive sometimes leave. This can be prevented by placing a trap at the entrance to retain the queen. Artificial swarming should not be practiced too early as the bees are apt to swarm naturally later.

SECURING THE HARVEST.

PREPARATION.

Emphasis has been laid on the necessity of securing a large force of bees ready to gather the nectar, when the flow comes on. It is no doubt true, that for a varying period after emerging, the young bees engage in duties on the inside of the hive before going into the field. This period is usually about two weeks. By adding this time to the three weeks required for the development from egg to the emerged insect, it would seem that it requires usually about five weeks to develop a field bee. For most of the State of Maryland the fruit bloom and other early flowers is usually sufficient to be of decided aid in stimulating brood rearing for the harvest to be secured later from white clover. Stimulative feeding will no doubt prove profitable especially in those years when fruit bloom honey is scarce or entirely lacking.

EXTRACTED HONEY.

Honey may be secured either as extracted or comb honey. It is doubtless true that the bee keepers of Maryland, have given far too little attention in the past to the production of extracted honey. It is not intended to include under the term extracted honey, the product secured by mashing combs, honey, pollen and perhaps an occasional cell containing brood into one mass and straining the whole through cloth.

Extracted honey is secured from frames of comb that have been

allowed to remain on the hive long enough to properly ripen. The cappings are removed from the comb by a sharp knife, after which the frame is put in an extractor (fig. 21.) and revolved rapidly enough

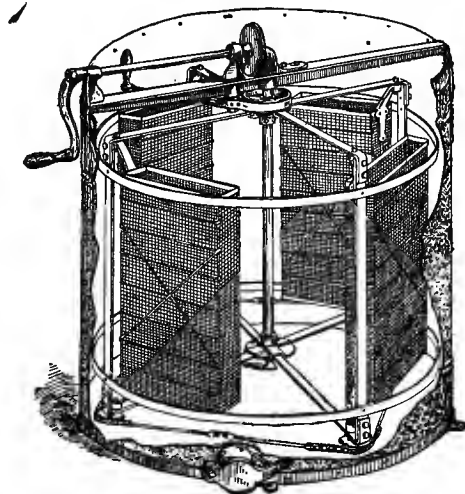

Fig. 21.—Extractor.

to throw the honey from the cells. The frames of comb are then returned to the hive to be filled again by the bees. The bees consume honey in order to be able to secrete wax for comb building. The amount of honey thus required has been variously estimated. It has been stated that for every pound of wax secreted the bees consume 15 to 20 pounds of honey. Certainly there is economy indicated in the production of extracted honey where the combs are used over and over again.

In extracting, the cappings are removed with knives especially made for this purpose. (Fig. 22.) A butcher's knife is used by some and

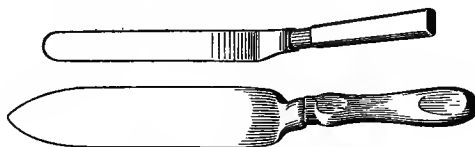

Fig. 22.—Uncapping knives.

found to be satisfactory. Two or more knives are needed, the one not in immediate use being immersed in hot water to keep it clean and warm.

Care must be taken that the honey is properly ripened in the hive before extracting, otherwise it may ferment. The care of honey after extracting cannot be given in detail here, but suffice it to say that it is

not usually bottled or otherwise sealed at once. The receptacles in which it is to be marketed may be left uncovered, and placed in a vessel containing hot water, using care that the flavor is not destroyed by too high a temperature. A temperature of 160 degrees F. but not higher should be maintained for some time, after which the receptacles are sealed at once, before the honey cools. Extracted honey that has granulated may be liquified in the same way using the same care in avoiding a temperature above 160 degrees F.

Frames that are of the same dimensions as the brood chamber are usually used as extracting frames. An eight or ten frame body of such frames filled solid with honey is, however, rather unwieldy, and it is

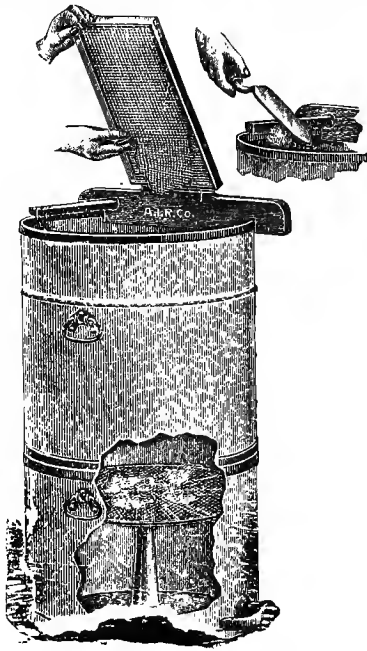

Fig. 23.—Uncapping can.

believed that a frame not so deep can be used to good advantage owing to ease of handling when the honey is removed for extracting.

COMB HONEY.

Not every locality presents conditions suitable for the production of comb honey. This product of the hive must be stored rapidly to produce an article which will command a good price on the market. Comb honey stored during a honey flow of several weeks is usually travel stained, propolized and otherwise soiled and the combs are often irregular so that it is no longer an attractive article. The long honey flow is more suitable for the production of extracted honey.

Localities in which the flora yields only a more or less dark grade of honey are not suitable for the production of comb honey, since the appearance of comb honey is an important factor in its profitable marketing. Pound for pound the best grade of comb honey is worth about five cents more than the best grade of extracted. It should be borne in mind, however, that the yield per colony of comb honey is less than the yield of extracted honey. The demands of the available market will, however, be an important factor in determining the kind of product. The important thing to know, however, is that any locality that will yield nectar at all is adapted to extracted honey production, while the profitable production of comb honey requires peculiar conditions and unless these are present it certainly will not be wise to attempt it.

Comb honey is produced and marketed in small wooden frames known as sections. The sections which are in use vary somewhat as to dimensions, but all approximate more or less closely a pound in weight when filled. Sections are arranged in rows in the super and fit very closely in order not to leave open space for the depositing of propolis. The rows of sections are separated by a wooden slat or separator of which there are several kinds in use. The bees are enabled to pass from the brood chamber to the sections by one of two methods. Either the edges of the section are cut away to provide space between it and the separator, or the separator may have cleats attached, which coin-

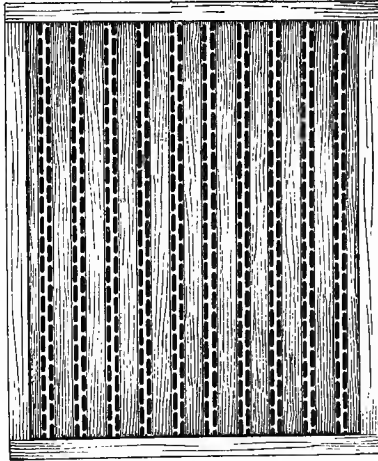

Fig. 24.—Zinc excluder.

cide with the edge of the section. In addition the separator may be made up of separate slats much after the manner of a board fence, allowing passage for the bees from section to section.

Either narrow strips or full sheets of foundation may be used in the sections. Sections should be folded, foundation put in, and supers arranged with sections in advance of the season in order that there may be no delay in getting the surplus receptacles on the hives when the rush of the honey flow comes on. Perhaps the largest amount of comb honey produced in Maryland comes from the white clover flow which

sometimes lasts only a short time. From this it will be understood how imperative it is to have a large force of worker bees at the right time.

The queen should be kept below by the use of a sheet of perforated zinc. (Fig. 24.). The treatment of swarms has been described under the topic "swarming." Add supers as they are needed, so that crowding does not result. After the first super is about half filled with honey, lift it up and put the second super under it. This insures comb building in the sections, which can later be filled with honey. It takes abundant nectar secretion for the bees to secrete wax, hence the comb in the

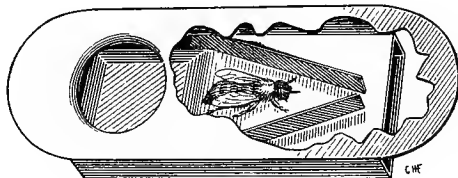

Fig. 25.—Spring bee escape.

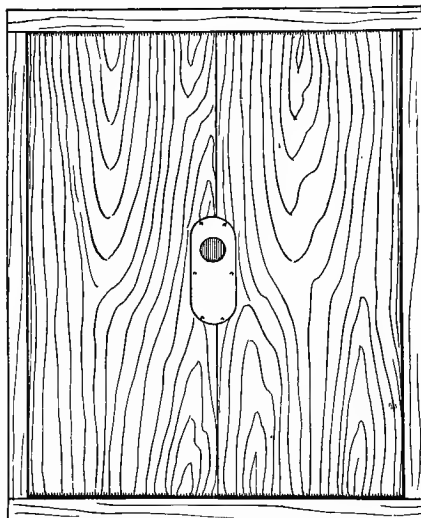

Fig. 26.—Bee escape in board.

sections should be started early in the flow. If there is prospect of the honey flow coming to an end soon, it may be necessary to change supers again, in order to get the first sections filled out in first class condition. It may be desirable even to remove some of the supers at this time or a little later as the flow draws to a close.

Comb honey production requires skillful manipulation of supers which the bee keeper acquires only by study and practice. Sections not filled and capped sufficiently for the market, should be retained for use as "bait" sections, for next year. These are put at the sides of the super where owing to the low temperature the bees are slow to build

comb and store honey. Comb honey should not be allowed to remain in the hive long after capping owing to liability of the bees soiling the face of the section with propolis and old wax. Sections soiled by the bees in this manner are described as "travel-stained." Comb honey is easily removed by the use of a bee escape which clears the super of bees. (Figs. 25 and 26.)

MARKETING THE CROP.

Judicious marketing of the crop may often largely measure the profits of the bee keeper. The securing of a crop of honey is only partly indicative of the success to be attained. Many bee keepers, especially those who keep only a few colonies, are too often inclined to sell at too low a figure. The aggregate of the output, often of an inferior quality, of such indifferent bee keepers, frequently makes it impossible for others to profitably market a good article. It is the duty of the State and County Bee Keepers Association to institute and maintain a vigorous campaign for the education of the bee keepers of the State in profitable methods of marketing.

Carefully grade all honey so that each lot is of uniform quality; do not attempt to mix a few soiled sections with a No. 1 article on the assumption that the first class article will aid the sale of a second or third grade. Carefully scrape the wood of sections free of propolis and bits of wax, and pack in the regulation shipping case. Grading rules for comb honey are published in all of the bee journals. The style and size of package for extracted honey will depend on the demands of the market in which the bee keeper disposes of his product. A fancy article in a neatly labeled glass package will more than repay the extra cost, in added sales and increased price obtained.

THE PRODUCTION OF WAX.

The saving of the wax that accumulates about the apiary may add not a little to the income of the bee keeper. This is especially true if much extracted honey is produced owing to the accumulated cappings and scrapings from the frames. There are a number of wax presses of varying degrees of efficiency for sale by supply dealers. The various apparatus and methods used in wax extraction are described in books and journals relating to bee keeping. The subject is too extensive to be discussed in the limited space of this bulletin.

WINTERING.

The wintering of bees in Maryland presents so few difficulties that a discussion of this subject does not seem justifiable. Colonies that go into winter quarters strong in bees and with properly ripened and sufficient stores, will usually pass through the winter in good condition.

DISEASES.

Of the diseases which attack bees the greatest losses arise from the two infectious diseases of the young brood, viz., American Foul Brood and European Foul Brood.

American Foul Brood is characterized by a ropiness of the affected brood, manifested by thrusting a wooden splinter into the dead brood and removing it. In some cases the ropy mass can be drawn out to the extent of 3 or 4 or more inches. Later this ropy mass dries and forms a dark brown scale on the lower cell wall usually adhering tightly. The color of this decayed mass in the earlier stages before drying down is a light brown. The dead brood may be either capped or uncapped and the cappings are often sunken and perforated. The odor in American Foul Brood is usually marked and perhaps more noticeable after the mass has dried down to form the scale. This odor is not always unpleasant. It has been likened to that of a glue pot, which perhaps is as descriptive a comparison as can be made. This disease rarely attacks drone larvæ.

In European Foul Brood there is not the tendency toward ropiness, as in American Foul Brood, although a slight degree of ropiness does sometimes occur. The scale that forms in this disease does not adhere as a rule very closely to the cell wall and is more usually found at the base of the cell. These scales often show lines running around the dead grub, marking it off into divisions. The color of the scales is a yellowish brown or gray, sometimes quite dark brown. In the earlier stages before drying down the larva is of a yellowish or gray color and has what might be called a "melting" appearance, by which it is understood that the larva becomes a moist collapsed mass. The brood in this disease is not so often capped as it is in American Foul Brood, since it is the younger larva that are more often attacked. The disease attacks queen and drone larvæ as well as worker brood.

The adult bees of a colony affected with either of these diseases do not seem to work with their usual activity, and the bee keeper will probably note a general listlessness about the hive. Owing to the large amount of brood dying, the colony constantly dwindles in strength, often becoming so weak that robbers enter and spread the infection to other hives in the apiary.

In these two diseases there is great variation, so that it is not a simple matter to give a general description applicable in every detail to all cases. Variation occurs in both of these diseases, and they may become so much alike in appearance that in some cases the distinguishing of the one from the other requires considerable care. In case there is any doubt in the mind of the bee keeper about diagnosis the Bureau of Entomology, United States Department of Agriculture, Washington, D. C., is always willing to aid the bee keeper by examining samples of brood suspected of being diseased. Neither of these diseases can be diagnosed from empty comb, honey, or dead adult bees. Hence, in suspected cases larvæ of the age at which the disease has been described as attacking the brood should be sent. A piece of comb four or five inches square is sufficient.

If a honey flow is on so that there is no danger from the spread of the infection by robbing, the diseased colony or colonies should be at once by shaking. This is done in the following manner: Prepare a clean hive containing new frames with strips of foundation about $\frac{1}{4}$ inch wide. Set this hive on the old stand, having previously moved the old hive away a foot or two to one side so that it is within easy reach. If the bees are to be shaken directly into the new hive from the top, some of the central frames with starters should be taken out to make a clear space into which the old frames covered with bees can be lowered. Each frame from the old hive is to be taken out separately, lowered into the new hive as above stated and given several vigorous up and down shakes to dislodge all of the bees. A third empty hive body should be near at hand to receive the old frames as fast as the bees have been dislodged. Both the old hive from which frames with bees are being taken, and the third hive body into which they are placed after shaking should be provided with close fitting covers and bottoms, and closed entrances so that no robber bees may enter to carry away infected material. After all the bees are shaken into the new hive, put in the remaining new frames previously removed to make space for shaking. Close the hive and put a queen trap at the entrance to prevent the colony from swarming out. Bees on being shaken into a hive provided only with starters without comb, eggs or brood sometimes leave. The excluder is intended to prevent this. Alley's queen and drone trap (Fig. 20) is suitable for this purpose. The bees are not to be given any food for 48 hours and not even then if honey is coming in from the field.

There is nearly always a little unsealed honey in the combs, a part of which will be shaken out into the hive. This can be left, as it is concealed from would-be-robbers when the hive is closed at the end of the shaking. A slight modification may be suggested here. If the honey flow is heavy so that a large amount of honey is shaken out it is better to shake the bees at the entrance on a run-way board inclined at a gentle slope. This may be covered with paper and the soiled paper destroyed later.

If there is considerable brood in the old infected combs it can be saved by placing the frames over a weak diseased colony. This allows the young bees which emerge to go below, thus strengthening the colony, which later is treated also, as just described. In case it is not desirable to save the brood, all of the old infected combs can be carried to the honey house and rendered into wax as soon as possible. This can be done by thoroughly boiling in hot water. To secure all of the wax the slumgum or debris remaining after boiling should afterwards be run through a wax press.

It is rarely advisable to try to save the honey yet if this is desired it should first be extracted. Honey thus obtained from old infected combs must be diluted with about an equal amount of water, and boiled in a closed vessel directly over the flame for one hour. Heating in one receptacle set inside of another containing boiling water is not safe as the spores will not be killed. It will be readily understood that this honey can be used for no other purpose than feeding back to the bees

at some future time, as it is almost certain to be somewhat scorched. It should never be used for winter stores.

The old frames should be burned as they are not worth saving. Old hive bodies should be scorched until the wood is slightly charred. A painter's torch can be used to good advantage for this purpose, and in case this is not available a little gasoline may be poured in on straw and ignited. Caution must be exercised in using such inflammable material.

As before said, the shaking treatment is to be recommended only when a honey flow is on, in order to prevent robbers carrying the infection to other hives in the apiary. If there is a dearth of nectar, it is better to wait for a flow unless the colony is too weak to make this safe. The entrance of all infected and weak colonies should be contracted to reduce chance of robbers entering. If there is no prospect of another honey flow, then a tent made of mosquito netting supported on a light wooden frame can be used. This should be large enough to permit the easy movement of the operator in manipulating.

Another disease attacking the brood late in the larval stage is the so-called "pickle brood." The cause of this disease is not known. It usually disappears of its own accord and no treatment is recommended.

Dysentery has been mentioned in another part of this bulletin.

"Paralysis" is a malady in which the bees are described as being seized with a peculiar trembling. No treatment can be recommended.

INSECT ENEMIES.

Of the other enemies which attack bees the two wax moths are the most important. There are two species of these, the large wax moth (*Galleria mellonella* L.) and the lesser wax moth (*Achroia grisella* Fab.). The larvæ of these moths hatch from eggs that have been deposited on the combs and on bits of wax about the hive. They do much damage even destroying completely whole frames of comb. No trouble will be experienced if the colonies are kept strong with bees.

To destroy the larvæ of the wax moth in combs outside of the hive, tier the bodies and place a quantity of carbon bisulphid in a saucer in an empty super placed at the top of the tier. The gas is heavier than the air and sinks down through all of the hive bodies. Care should be used not to bring a flame near the tiers of hives as the gas is highly inflammable.

MISCELLANEOUS INFORMATION.

HIVE RECORDS.

The bee keeper should keep a record to be preserved in permanent form of each and every colony in the apiary. The hives should be numbered and entries made in book or card form for each hive. By referring to this written record from time to time, the manipulation of the colonies can be undertaken with more certainty of intelligent action. This is particularly applicable to an apiary of considerable size.

Thus by making note of the time when honey begins to be stored in the supers, and later of the time of cessation of the flow, an idea can be attained of the length of the honey flows, which as before mentioned is particularly important for the producer of comb honey. Records will also be desired of the date of introduction of new queens, and of their activity after being introduced, and of many other items of information too numerous to mention.

The numbering device should be detachable so that it can be easily put in place and as easily removed. This will be appreciated when it is remembered that the old hive body will often be removed and a new hive body bearing the old number put in its place on the old stand, as in swarming and numerous other manipulations.

Numbering devices can be of wood or metal. Pieces of section with black figures stenciled against a white background are a cheap and satisfactory device. These can be slid in and out between three staples as shown on previous cuts in this bulletin. Some arrangement whereby the numbering tag would be flush with the hive body instead of projecting as the piece of section mentioned, would be an improvement. Circular metal tags, countersunk by means of an auger, would fulfill this requirement.

LITERATURE ON BEE KEEPING.

Books and Journals. The bee keeper will find at least one good journal and one or more books relating to apiculture to be indispensable. Of the journals, *Gleanings in Bee Culture*, published at Medina, Ohio; *The American Bee Journal*, published at Chicago, Illinois, and *The Bee Keepers' Review*, published at Flint, Michigan, are the three publications issued in this country.

Of the books on bee keeping there are many from which to select. The following will be found valuable:

ABC and XYZ of Bee Culture, A. I. Root, Co., Medina, Ohio.

Langstroth on the Hive and Honey Bee, C. P. Dadant, Hamilton, Ill.

Manual of the Apiary, A. J. Cook, Claremont, California.

Dr. Miller's Forty Years Among the Bees, Geo. W. York, 117 N. Jefferson St., Chicago, Ill.

Advanced Bee Culture, W. Z. Hutchinson, Flint, Michigan.

The literature should include catalogues of manufacturers of hives, and other bee supplies. These will be found to contain much valuable information.

Government Publications. There are several publications of the Department of Agriculture which are of interest to bee keepers and new ones are added from time to time in regard to the different lines of investigation.

The following publications relating to bee culture, are for free distribution and may be obtained by addressing the Secretary of Agriculture, Washington, D. C.

This list is taken from *Farmers' Bulletin* 447.

BUREAU OF ENTOMOLOGY.

Farmers' Bulletin No. 447, "Bees." By E. F. Phillips, Ph. D. 1911. 48 pp., 25 figs.

A general account of the management of bees.

Farmers' Bulletin No. 442, "The Treatment of Bee Diseases." By E. F. Phillips, Ph. D. 1911. 22 pp., 7 figs.

This publication gives briefly the symptoms of the various bee diseases, with directions for treatment.

Circular No. 94, "The Cause of American Foul Brood." By G. F. White, Ph. D. 1907. 4 pp.

This publication contains a brief account of the investigations which demonstrated for the first time the cause of one of the brood diseases of bees, American foul brood.

Circular No. 138, "The Occurrence of Bee Diseases in the United States. (Preliminary Report.)" By E. F. Phillips, Ph. D. 1911. 25 pp.

A record of the localities from which samples of diseased brood were received prior to March 1, 1911.

Bulletin No. 55, "The Rearing of Queen Bees." by E. F. Phillips, Ph. D. 1905. 32 pp., 17 figs.

A general account of the methods used in queen rearing. Several methods are given, so that the bee keeper may choose those best suited to his individual needs.

Bulletin No. 70, "Report of the Meeting of Inspectors of Apiaries, San Antonio, Tex., November 12, 1906." 1907. 79 pp., 1 plate.

Contains a brief history of bee-disease investigations, an account of the relationship of bacteria to bee diseases, and a discussion of treatment by various inspectors of apiaries and other practical bee keepers who are familiar with diseases of bees.

Bulletin No. 75, Part I, "Production and Care of Extracted Honey." By E. F. Phillips, Ph. D. "Methods of Honey Testing for Bee Keepers." By C. A. Browne, Ph. D. 1907. 18 pp.

The methods of producing extracted honey, with special reference to the care of honey after it is taken from the bees, so that its value may not be decreased by improper handling. The second portion of the publication gives some simple tests for adulteration.

Bulletin No. 75, Part II, "Wax Moths and American Foul Brood." By E. F. Phillips, Ph. D. 1907. Pp. 19-22, 3 plates.

An account of the behavior of the two species of wax moths on combs containing American foul brood, showing that moths do not destroy the disease-carrying scales.

Bulletin No. 75, Part III, "Bee Diseases in Massachusetts." By Burton N. Gates. 1908. Pp. 23-32, map.

An account of the distribution of the brood diseases of bees in the State, with brief directions for controlling them.

Bulletin No. 75, Part IV, "The Relation of the Etiology (Cause) of Bee Diseases to the Treatment." By G. F. White, Ph. D. 1908. Pp. 33-42.

The necessity for a knowledge of the cause of bee diseases before rational treatment is possible is pointed out. The present state of knowledge of the causes of disease is summarized.

Bulletin No. 75, Part V, "A Brief Survey of Hawaiian Bee Keeping." By E. F. Phillips, Ph. D. 1909. Pp. 43-58, 6 plates.

An account of the beekeeping methods used in a tropical country and a comparison with mainland conditions. Some new manipulations are recommended.

Bulletin No. 75 Part VI, "The Status of Apiculture in the United States." By E. F. Phillips, Ph. D. 1909. Pp. 59-80.

A survey of present-day beekeeping in the United States, with suggestions as to the work yet to be done before apiculture will have reached its fullest development.

Bulletin No. 75, Part VII. "Bee Keeping in Massachusetts." By Burton N. Gates. 1909. Pp. 81-109, 2 figs.

An account of a detailed study of the apicultural conditions in Massachusetts. The object of this paper is to point out the actual conditions and needs of beekeeping in New England.

Bulletin No. 75, Contents and Index. 1911. Pp. VIII+111-123.

Bulletin No. 75, Parts I-VII, complete with Contents and Index. 1911. Pp. VIII+123.

Bulletin No. 98, "Historical Notes on the Causes of Bee Diseases." By E. F. Phillips, Ph. D., and G. F. White, Ph. D., M. D. (In press.)

A summary of the various investigations concerning the etiology (cause) of bee diseases.

Technical Series, No. 14, "The Bacteria of the Apiary, with Special Reference to Bee Diseases." By G. F. White, Ph. D. 1906. 50 pp.

A study of the bacteria present in both the healthy and the diseased colony, with special reference to the diseases of bees.

Technical Series No. 18, "The Anatomy of the Honey Bee." By R. E. Snodgrass. 1910. 162 pp., 57 figs.

An account of the structure of the bee, with technical terms omitted so far as possible. Practically all of the illustrations are new, and the various parts are interpreted according to the best usage in comparative anatomy of insects. A brief discussion of the physiology of the various organs is included.

BUREAU OF CHEMISTRY.

Bulletin No. 110, "Chemical Analysis and Composition of American Honeys." By C. A. Browne. Including "A Microscopical Study of Honey Pollen." By W. J. Young. 1908. 93 pp., 1 fig., 6 plates.

A comprehensive study of the chemical composition of American honeys. This publication is technical in nature and will perhaps be little used by practical bee keepers, but it is an important contribution to apicultural literature. By means of this work the detection of honey adulteration is much aided.

HAWAII AGRICULTURAL EXPERIMENTAL STATION, HONOLULU, HAWAII.

Bulletin No. 17, "Hawaiian Honeys." By D. L. Van Dine and Alice R. Thompson. 1908. 21 pp., 1 plate.

A study of the source and composition of the honeys of Hawaii. The peculiar conditions found on these islands are dealt with.

PUBLICATIONS OF

The Maryland Agricultural Experiment Station

These Bulletins are sent free of charge to any address upon application.

Only the Bulletins named below are available for distribution.

Bulletin No.	58, Aug.,	1898,	The Hessian Fly and Wheat Diseases.
" "	61, June,	1899,	The Sugar Beet in Maryland.
" "	73, April,	1901,	Suggestions About Combatting the San Jose Scale.
" "	75, June,	1901,	The Effect of Hydrocyanic-Acid Gas on Grains and Seeds.
" "	87, Nov.,	1902,	The Periodical Cicada or Seventeen-Year Locust.
" "	89, June,	1903,	Experiments with Potash Fertilizers.
" "	102, May,	1905,	The Leucocytes in Milk and Their Significance.
" "	103, June,	1905,	Methods of Tobacco Seed Selection.
" "	104, July,	1905,	Tests of Materials for Bedding Cows.
" "	110, Sept.,	1906,	Investigations on Liming Soils.
" "	119, July,	1907,	Greenhouse Pests in Maryland.
" "	121, Sept.,	1907,	Beef Cattle Industry of Maryland.
" "	122, Oct.,	1907,	Stable Manure Experiments.
" "	123, Nov.,	1907,	The San Jose Scale and Peach Lecanium.
" "	124, Dec.,	1907,	Strawberries.
" "	125, Feb.,	1908,	Nut Growing in Maryland.
" "	126, April,	1908,	Manuring and Fertilizing Truck Crops.
" "	127, May,	1908,	Miscellaneous Greenhouse Notes.
" "	128, June,	1908,	The Effect of Animal Digestion and the Fermentation of Manure on the Vitality of Seeds.
" "	129, July,	1908,	Silos and Silage in Maryland.
" "	130, Aug.,	1908,	Nurseries and Nursery Inspection.
" "	131, Nov.,	1908,	Treatment for San Jose Scale.
" "	133, March,	1909,	Cabbage Experiments and Culture.
" "	134, April,	1909,	Brown-Tail Moth, House Fly, Mosquitoes.
" "	135, May,	1909,	Butter-Making in Maryland.
" "	136, June,	1909,	Whipped Cream.
" "	137, July,	1909,	The Angoumois Grain-Moth.
" "	138, Aug.,	1909,	The Poultry Industry in Maryland.
" "	141, Jan.,	1910,	Corn, Variety Tests, Seed, Selection, Testing, and Breeding.
" "	142, Feb.,	1910,	The Codling Moth.
" "	143, Feb.,	1910,	Plant Diseases and Spray Calendar.
" "	144, Feb.,	1910,	Apple Culture.
" "	145, June,	1910,	Tuberculosis of Animals.
" "	146, July,	1910,	Poultry House Construction.
" "	147, Aug.,	1910,	Wheat—Variety Test, Smuts and Scab.
" "	148, Nov.,	1910,	For the Control of San Jose Scale.
" "	140, Dec.,	1910,	The Terrapin Scale.
" "	150, Jan.,	1911,	Hog Feeding and Hog Houses.
" "	151, Feb.,	1911,	Fertilizers for Asparagus.
" "	152, Apr.,	1911,	Aphidinae of North America.
" "	153, May,	1911,	Bacteria and Animal Organisms Found in the Feces of Chickens.
" "	154, June,	1911,	Bee Keeping in Maryland.

CONTENTS.

BEEKEEPING IN MARYLAND.

I. The Status of Beekeeping in the State.

By T. B. SYMONS.

Introduction	227
The Needs of Such an Investigation.....	229
The Distribution of Bees in the State.....	229
Increases and Loss of Colonies.....	230
Production of Honey and Wax.....	230
Sources of Honey.....	231
Average Experience of Beekeepers; Hives and Kind of Bees....	236
Bee Diseases in the State.....	236
The Needs of the Industry in Maryland.....	239

II. The Management of Bees.

By ARTHUR H. McCRAY.

Introduction	237
Equipment of the Apiary.....	242
The Apiary, Its Location and Size.....	247
Transferring, General Manipulations.....	249
Spring Management.....	253
Swarming	256
Securing the Harvest.....	258
Marketing the Crop.....	263
The Production of Wax.....	263
Wintering	263
Diseases	264
Insect Enemies.....	266
Miscellaneous Information.....	266

**Photomount
Pamphlet
Binder
Gaylord Bros.
Makers
Syracuse, N. Y.
PAT. JAN 21, 1908**

